









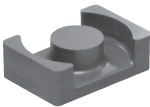

FR	2-3 / 16
EN	4-5 / 16
DE	6-7 / 16
ES	8-9 / 16
RU	10-11 / 16
NL	12-13 / 16
IT	14-15 / 16



Remplacement des ferrites



Replacement of ferrites
Austausch von Ferritkernen
Reemplazo de ferritas
Замена феррита
Vervangen van inductie-ferrieten
Sostituzione delle ferriti

Si un inducteur a dans sa dénomination le nom d'une ferrite, alors ce dernier est remplaçable sans outillage spécifique.

Ferrites			
B1	B2	B3	B4
			
Protection ferrites			
B1	B2	B3	B4
			



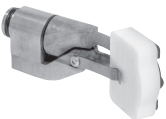
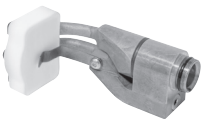
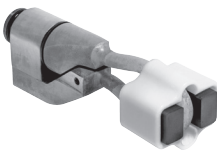



Inducteurs concernés

C20 / B1	C180 / B1	C180 / B2
		

S20 / B1	S180 / B1	S180 / B2	S180 / B3W	L20 / B4
				

Inducteurs non concernés

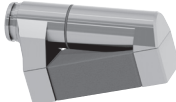
Pour les autres modèles, remplacer l'inducteur complet ou contacter le SAV.

S90	S70	S180	L90	L70	L180
					

REEMPLACER UN FERRITE

1. Dévisser la vis de la lamelle ressort de maintien si présent (**B1 & B4**).
2. Retirer ou faire glisser la protection en PTFE (blanche, **B2 & B3**)
3. Retirer la ferrite usagé.
4. Retirer les traces de colle et nettoyer les éléments en cuivre.

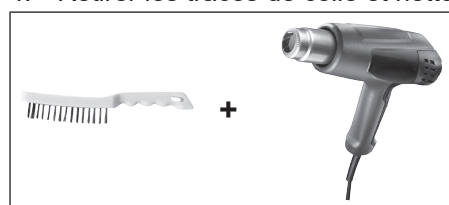

5. Utiliser un grattoir ou chauffer avec un décapeur thermique (066311) et frotter avec une brosse métallique (044241).



Ne pas monter l'inducteur à plus de 100°C au risque de détériorer les joints.

6. Finir avec du scotch brite ou du papier de verre.
7. Pour un résultat optimum du collage, il faut que le cuivre soit exempt de toutes traces.



Avant remontage de la ferrite, il faut l'emboîter dans la protection en PTFE.

8. Déposer de la colle à l'aide du kit de colle (075948).
→ tube de colle supplémentaire (054851)
9. Positionner l'ensemble sur l'inducteur précédemment préparé (nettoyage).







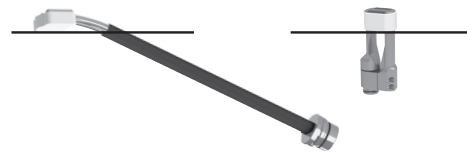

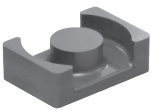

10. Revisser la vis de la lamelle ressort de maintien si présent (**B1 & B4**) ou remonter la protection sur la ferrite (**B2 & B3**).
11. Essuyer le surplus de colle.

12. Maintenir l'inducteur avec la ferrite à l'horizontale.

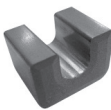





Attendre au minimum 4h, avant manipulation. La prise peut être accélérée en chauffant (max 60°C).

If the name of a complete inductor includes the name of a ferrite, then it can be replaced without specific tools.

Ferrites			
B1	B2	B3	B4
			
Ferrite protectors			
B1	B2	B3	B4
			



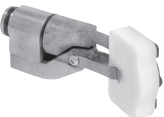
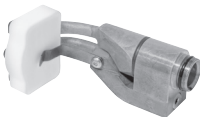
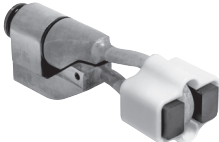

Relevant inductors

C20 / B1	C180 / B1	C180 / B2
		

S20 / B1	S180 / B1	S180 / B2	S180 / B3W	L20 / B4
				

Irrelevant inductors

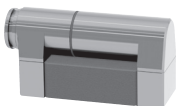
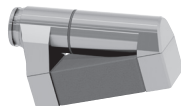
For other models, replace the complete inductor or contact the Aftersales department.

S90	S70	S180	L90	L70	L180
					

REPLACE THE FERRITE

1. Unscrew the retaining spring plate screw if present (B1 & B4).
2. Remove or slide off the white PTFE cover (B2 & B3)
3. Remove the used ferrite.
4. Remove all remaining glue, and clean the exposed copper elements.

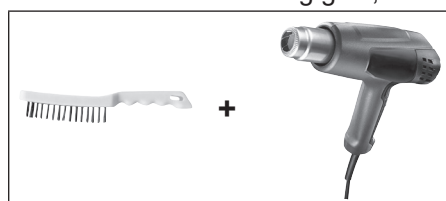

5. Use a scraper or apply heat with a heat gun (066311) and clean with a wire brush (044241).

 Do not mount the inductor at more than 100°C at the risk of damaging the joints.

- 6. Finish with Scotch-Brite or sandpaper.
- 7. For optimum bonding results, the copper piping must be clean and free of all traces of glue.



Before reassembling the ferrite, it must be fitted in the PTFE cover.

- 8. Apply glue using the glue kit (075948).
→ extra tube of glue (054851)
- 9. Position the ferrite assembly on the previously prepared/cleaned inductor.





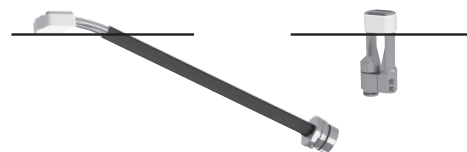



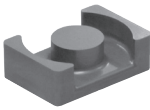

- 10. Retighten the retaining spring plate screw if present (B1 & B4) or refit the protective cover on the ferrite (B2 & B3).
- 11. Wipe off excess glue.
- 12. Position the inductor so the ferrite is horizontal.

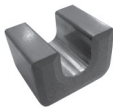





Wait at least 4 hours before handling. The setting/drying of the glue can be accelerated by heating (max 60°C).

Wenn ein Induktor in seiner Bezeichnung den Namen eines Ferritkerns trägt, dann ist der Ferritkern ohne Spezialwerkzeug austauschbar.

Ferritkerne			
B1	B2	B3	B4
			
Schutz der Ferritkerne			
B1	B2	B3	B4
			



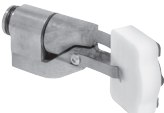
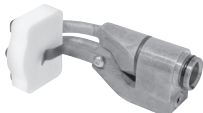
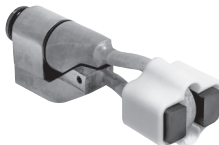

Betroffene Induktoren

C20 / B1	C180 / B1	C180 / B2
		

S20 / B1	S180 / B1	S180 / B2	S180 / B3W	L20 / B4
				

Nicht betroffene Induktoren

Bei anderen Modellen tauschen Sie den kompletten Induktor aus oder wenden sich an den Kundendienst.

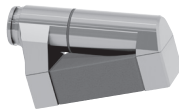
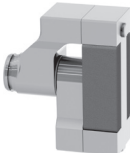
S90	S70	S180	L90	L70	L180
					

EINEN FERRITKERN AUSTAUSCHEN

1. Lamelle der Niederhaltefeder lösen, falls vorhanden (**B1 & B4**).
2. Entfernen oder Verschieben des PTFE-Schutzes (weiß, **B2 & B3**)
3. Den defekten Ferritkern entfernen.
4. Entfernen Sie Klebstoffspuren und reinigen Sie die Kupferelemente.

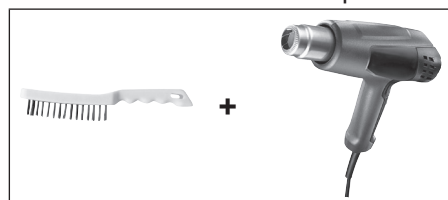

5. Verwenden Sie einen Schaber oder erhitzen Sie mit einem Heißluftgebläse (066311) und schrubben Sie mit einer Drahtbürste (044241).



Montieren Sie den Induktor nicht bei mehr als 100 °C, da sonst die Dichtungen beschädigt werden können.

6. Vorgang mit Schleifring oder Schleifpapier durchführen
7. Um ein optimales Ergebnis beim Kleben zu erzielen, muss das Kupfer frei von Schmutz sein.



Bevor der Ferritkern wieder zusammengesetzt wird, muss er in der PTFE-Schutzkappe eingepasst werden.

8. Kleber aus dem Klebest (075948) auftragen.
→ weitere Tube Klebstoff (054851)
9. Positionieren Sie die Baugruppe auf dem zuvor vorbereiteten Induktor (gereinigt).



10. Schrauben Sie die Lamelle der Niederhaltefeder wieder an, falls vorhanden (**B1** & **B4**), oder bringen Sie die Schutzkappe des Ferritkernes (**B2** & **B3**) wieder an.
11. Wischen Sie überschüssigen Kleber ab.
12. Halten Sie den Induktor mit dem Ferritkern waagrecht.

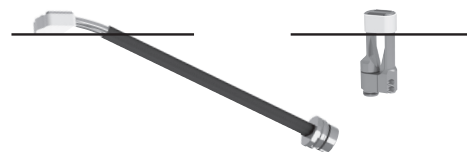

Vor der Anwendung mindestens 4 Stunden warten. Das Aushärten des Klebers kann durch Erwärmen (max. 60 °C) beschleunigt werden.

Si un inductor tiene el nombre de una ferrita en su nombre, entonces la ferrita es reemplazable sin herramientas especiales.

Ferritas			
B1	B2	B3	B4
Protección de la ferrita			
B1	B2	B3	B4

Inductores pertinentes

C20 / B1	C180 / B1	C180 / B2

S20 / B1	S180 / B1	S180 / B2	S180 / B3W	L20 / B4

Inductores no pertinentes

Para otros modelos, sustituya el inductor completo o póngase en contacto con el Servicio Postventa.

S90	S70	S180	L90	L70	L180

SUSTITUIR UNA FERRITA

1. Desenrosque el tornillo de la placa de resorte si está presente (B1 y B4).
2. Retire o deslice la cubierta de PTFE (blanco, B2 y B3)
3. Retire la ferrita usado.
4. Elimine los restos de pegamento y limpie los elementos de cobre.

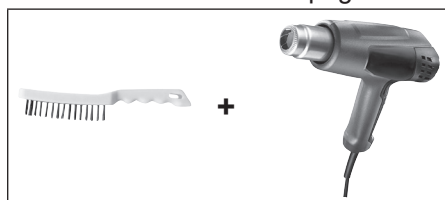

5. Utilice un raspador o caliente con un decapante térmico (066311) y frote con un cepillo de alambre (044241).



No monte el inductor a más de 100°C, ya que podría dañar las juntas.

6. Acabar con scotch brite o papel de lija.
7. Para obtener un resultado óptimo de adhesión, el cobre debe estar libre de toda traza.



Antes de volver a montar la ferrita, debe introducirse en la tapa de PTFE.

8. Aplique el pegamento con el kit de pegado (075948).
→ tubo de pegamento adicional (054851)
9. Coloque el conjunto sobre el inductor previamente preparado (limpieza).





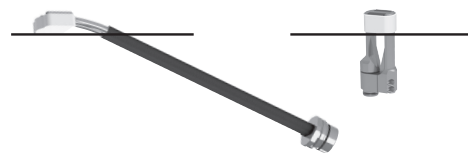



10. Vuelva a colocar el tornillo de la placa de resorte si está presente (B1 y B4) o vuelva a colocar la protección en la ferrita (B2 y B3).
11. Limpie el exceso de pegamento.
12. Mantener el inductor con la ferrita horizontal.

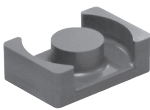

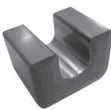
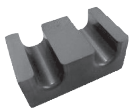



Esperar al menos 4 horas antes de manipularlo. El fraguado puede acelerarse calentando (max 60°C).

Если в названии индуктора есть название феррита, то феррит можно заменить без специальных инструментов.

Ферриты			
B1	B2	B3	B4
			
Защитная крышка для феррита			
B1	B2	B3	B4
			



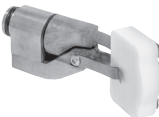
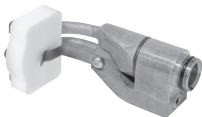
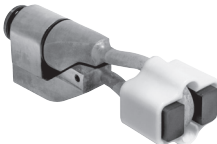



Соответствующие индукторы

C20 / B1	C180 / B1	C180 / B2
		

S20 / B1	S180 / B1	S180 / B2	S180 / B3W	L20 / B4
				

Неподходящие индукторы

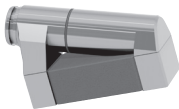
Для других моделей, полностью замените весь индуктор или обратитесь в службу послепродажного обслуживания.

S90	S70	S180	L90	L70	L180
					

ЗАМЕНИТЬ ФЕРРИТ

1. Открутите винт пружинной пластины, если она имеется (B1 и B4).
2. Снимите или сдвиньте крышку из ПТФЭ (тефлон) (белая крышка, B2 и B3)
3. Извлеките использованный феррит.
4. Удалите следы клея и очистите медные элементы.

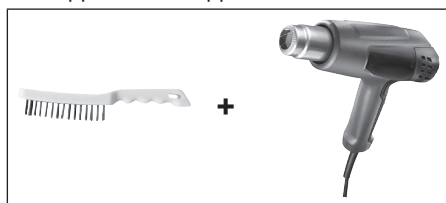

5. Используйте скребок или нагрейте с помощью средства для термической зачистки (066311) и почистите проволочной щеткой (044241).



Не нагревайте индуктор выше 100°C, так как это может привести к повреждению уплотнений.

6. Обработайте скотч-брайтом или наждачной бумагой.
7. Для достижения оптимальных результатов склеивания, медь должна быть очищена от всех следов.



Перед установкой, необходимо вставить феррит в тефлоновую защитную крышку.

8. Нанесите клей с помощью набора для клея (075948).
→ дополнительный тюбик клея (054851)
9. Установите комплект на предварительно очищенный и подготовленный индуктор.





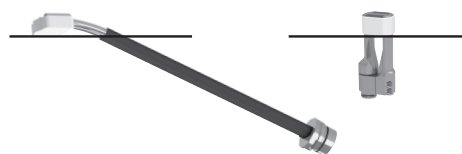



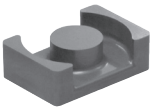

10. Замените винт на пружинной пластине, если он имеется (B1 и B4), или установите защитную крышку на феррит (B2 и B3).
11. Вытрите излишки клея.
12. Держите индуктор с ферритом горизонтально.

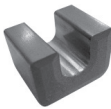





Подождите не менее 4 часов перед манипуляцией. Склеивание может быть ускорено нагреванием (максимум 60°C).

Als een inductor de naam van een inductie-ferriet in z'n omschrijving heeft, kunt u deze zonder speciaal gereedschap vervangen.



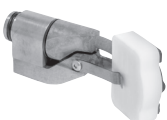
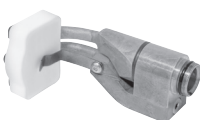
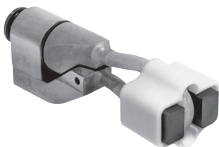



Inductie-ferrieten			
B1	B2	B3	B4
			
Bescherm-elementen			
B1	B2	B3	B4
			

Inductoren waarop dit van toepassing is

C20 / B1	C180 / B1	C180 / B2		
				
S20 / B1	S180 / B1	S180 / B2	S180 / B3W	L20 / B4
				

Inductoren waarop dit niet van toepassing is

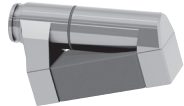
Voor de andere modellen moeten de complete inductoren vervangen worden, of kunt u contact opnemen met onze After Sales afdeling.

S90	S70	S180	L90	L70	L180
					

HET VERVANGEN VAN EEN INDUCTIE-FERRIET

1. Draai de schroef los van de lamel met springveer als deze aanwezig is (B1 & B4).
2. Nu kunt u het PTFE bescherm-element uit z'n positie laten glijden (wit, B2 & B3)
3. Verwijder de versleten inductie-ferriet.
4. Verwijder de achtergebleven lijmresten en reinig vervolgens grondig de koperen elementen.

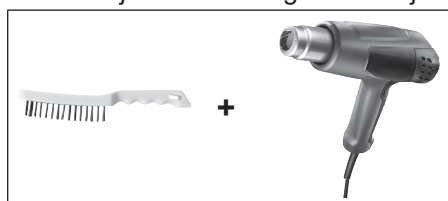

5. Maak gebruik van een krabber of warm op met behulp van een hete lucht pistool (066311) en borstel af met een metalen borstel (044241).



Verhit de inductor niet boven de 100°C, dit zou de pakkingen kunnen beschadigen.

6. Maak het geheel glad met Scotch Brite of schuurpapier.
7. Voor een optimaal lijm-resultaat moet het koper ontdaan zijn van alle oude lijmresten.



Voordat u de inductie-ferriet weer monteert, moet deze in z'n PTFE bescherm-element worden ingebracht.

8. Breng nu met behulp van de lijm-kit (075948) de nieuwe lijm aan.
→ extra tube lijm (054851)
9. Plaats het geheel op de reeds geprepareerde en goed schoongemaakte inductor.

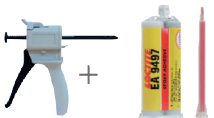

10. Draai de schroef van de lamel met springveer, indien aanwezig, weer aan (B1 & B4), of plaats het bescherm-element weer op de inductie-ferriet (B2 & B3).



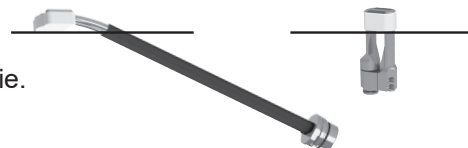





11. Verwijder de overtollige lijm.

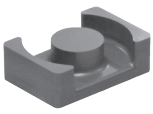

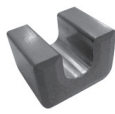

12. Houd de inductor met de inductie-ferriet in horizontale positie.



Wacht minimaal 4 uur voordat u de inductor gaat gebruiken. Het verharderen van de lijm kan worden versneld als u de inductor opwarmt (maximaal 60°C).

Se un induttore ha nel suo nome il nome di una ferrite, allora la ferrite è sostituibile senza strumenti speciali.

Ferriti			
B1	B2	B3	B4
			
Protezione ferriti			
B1	B2	B3	B4
			



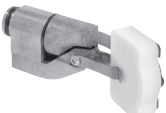
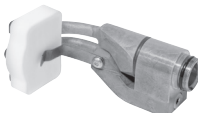
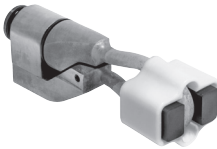

Induttori interessati

C20 / B1	C180 / B1	C180 / B2
		

S20 / B1	S180 / B1	S180 / B2	S180 / B3W	L20 / B4
				

Induttori non interessati

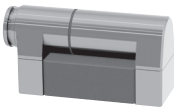
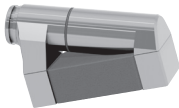
Per altri modelli, sostituire l'induttore completo o contattare il servizio di assistenza.

S90	S70	S180	L90	L70	L180
					

SOSTITUIRE ALA FERRITE

1. Svitare la vite della lamella di sostegno se presente (B1 & B4).
2. Rimuovere o sfilare la protezione in PTFE (bianco, B2 e B3)
3. Rimuovere la ferrite usata.
4. Rimuovere le tracce di colla e pulire gli elementi in rame.

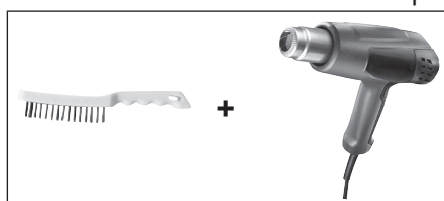

5. Utilizzare un raschietto o riscaldare con uno termosoffiatore (066311) e strofinare con una spazzola metallica (044241).



Non montare l'induttore a temperature superiori a 100°C per non danneggiare le guarnizioni.

6. Rifinire con scotch brite o carta vetrata.
7. Per ottenere risultati ottimali di incollaggio, il rame deve essere privo di tracce.



Prima di rimontare la ferrite, è necessario inserirla nella protezione in PTFE.

8. Applicare la colla utilizzando il kit di colla (075948).
→ tubo di colla supplementare (054851)
9. Posizionare il gruppo sull'induttore precedentemente preparato (pulizia).



10. Riavvitare la vite della lamella di sostegno se presente (B1 & B4) e rimontare la protezione sulla ferrite (B2 & B3).
11. Eliminare la colla in eccesso.

12. Mantenere l'induttore con il concentratore in posizione orizzontale.

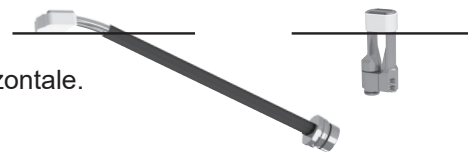

Attendere almeno 4 ore prima di maneggiarlo. L'indurimento può essere accelerato mediante riscaldamento (max 60°C).

**GYS France**

Siège social / Headquarter
1, rue de la Croix des Landes - CS 54159
53941 Saint-berthevin Cedex
France

www.gys.fr
+33 2 43 01 23 60
service.client@gys.fr

GYS Italia

Filiale / Filiale
Vega – Parco Scientifico Tecnologico di
Venezia
Via delle Industrie, 25/4
30175 Marghera - VE
Italia

www.gys-welding.com
+39 041 53 21 565
italia@gys.fr

GYS UK

Filiale / Subsidiary
Unit 3
Great Central Way
CV21 3XH - Rugby - Warwickshire
United Kingdom

www.gys-welding.com
+44 1926 338 609
uk@gys.fr

GYS China

Filiale / 子公司
6666 Songze Road,
Qingpu District
201706 Shanghai
China

www.gys-china.com.cn
+86 6221 4461
contact@gys-china.com.cn

GYS GmbH

Filiale / Niederlassung
Professor-Wieler-Straße 11
52070 Aachen
Deutschland

www.gys-schweissen.com
+49 241 / 189-23-710
aachen@gys.fr

GYS Iberica

Filiale / Filial
Avenida Pirineos 31, local 9
28703 San Sebastian de los reyes
España

www.gys-welding.com
+34 917.409.790
iberica@gys.fr